

NOVAFLEX[®]



Hi-Flow
Dry-Release
Couplings



*Advanced Fluid Handling Systems
by Novaflex*

Novaflex Hi-Flow Dry-Release™ Couplings 'HDC' **The Next Generation in Dry-Release Technology**

State of the art couplings designed to safely transfer the most aggressive and valuable product with minimum operator intervention

Applications

- Road/Rail tanker loading/discharge
- ISO retrofit & new build
- IBC containers
- Offshore rig supply
- Pharmaceutical processing
- Vapor Recovery
- Ship to shore/ship/rig transfer
- Ship manifold exchange
- Bulk loading/discharge
- Paints & inks
- Marine refuelling
- Bitumen transfer
- Brewery
- Food feedstock
- Hazardous waste transfer
- Aviation bunkering
- Exchange manifolds
- Blending pits
- Rail locomotive refuelling
- Tank top/bottom loading
- DEF - Diesel exhaust fluid



How it works

Turning the hose unit 15° clockwise locks the units together. The valves are still closed and are not opened until a further rotation of 90° has been performed and then the product flow is guaranteed. To close the valves and to unlock the units, reverse the procedure.

NovaFlex[®] Hi-Flow[™] Dry-Release[™] Couplings 'HDC'

NOVAFLEX[®] IS PROUD TO ANNOUNCE THE NEXT GENERATION HI-FLOW DRY-RELEASE[™] COUPLING - 'HDC'

The NovaFlex Group[®] recognizes the need for technological advancements in the fluid transfer industry including critical Dry-Release[™] coupling systems.

Developed jointly by the two industry leaders in fluid handling systems, NovaFlex and Roman Seliger engineering teams have pushed the performance boundaries of Dry-Release[™] couplings. The new NovaFlex Hi-Flow Dry-Release[™] Coupling range exceeds the performance of every compatible coupling available today.

Drawing on decades of real world application experience, the NovaFlex 'HDC' coupling optimizes every area of function and design to deliver a truly innovative and reliable safety coupling.

Superior ergonomic handle design for ease of use with safety gloves

Advanced sealing technology, extended seal life. Reduces number of seals required by half, only two 'O'-rings

Optimized valve arrangement offers up to 30% flow rate improvement

Advanced integral swivel design for ease of handling/reduced hose torque wear

Enhanced connection system greatly improves ease of operation in challenging environments

Optional operator engaged locking device



Benefits of NovaFlex 'HDC' Hi-Flow Dry-Release Coupling Technology

Offshore and Marine

Flow optimized: NovaFlex 'HDC' delivers significantly higher flow rates and lower pressure drop, offering reduced loading and turnaround times, reduced energy consumption and resulting in lower operating costs.

Improved connection: This unique NovaFlex 'HDC' feature makes connecting in challenging environments easy. Significantly less torque force needed to connect female coupler to male adapter, even under differential pressure.

Superior ergonomics: User friendly handle designs facilitate use with protective gloves. Optional locking mechanism as secondary indicator of valve engagement is accessible from handle.

Advanced swivel design: Latest PTFE based seal technology enables ease of use in low temperature environments, reducing maintenance time. Swivel design reduces hose torque; one of the leading causes of premature hose wear.

Pharmaceutical

Latest sealing technology: Significant maintenance cost reductions – number of seals in coupler reduced by 50%, coupled with enhanced flow performance.

Optimized valve arrangement: Minimizes residual product on disconnection and delivers flow rate improvement of up to 30%.

Optional locking feature: NovaFlex 'HDC' optional Interlock provides secondary operator indicator of complete valve engagement and prevents unintentional disconnection.

Optional selectivity feature: Prevents cross contamination in multi-product manifold/sampling/dosing applications.

Novaflex 'HDC' Couplers and Adapters are fully compatible with all brands conforming to NATO STANAG 3756 (PHE)

NovaFlex[®] - through constant improvement and innovation - is committed to providing industry leading fluid transfer solutions that mitigate risk; protect personnel, property and the environment.

NovaFlex[®] Hi-Flow[™] Dry-Release[™] Couplings 'HDC'

Benefits of NovaFlex 'HDC' Hi-Flow Dry-Release Coupling Technology

Oil and Gas

Optimized valve arrangement: Fully interlocked for safe and dry release. Delivers significantly higher flow rates especially with high viscosity liquids. In addition to traditional hydrocarbon product transfer, The Novaflex HDC[™] is also designed for the transfer of liquid propane and butane gas in both liquid and vapor phases, all in one design. No need for a separate model.

Enhanced service feature: Enables easy access to all key replacement components for rapid field service and seal replacement without removing coupler from the hose or loading arm.

Superior ergonomics: User friendly handle designs and optional locking mechanism offers predictable and reliable operation. Significantly less torque force required to connect and disconnect even under differential pressure.

Advanced swivel design: Latest PTFE based seal technology enables ease of use in low temperature applications, reducing maintenance. Swivel design reduces hose torque stress; one of the leading causes of premature hose wear.



Rail and Tanker

Improved connection: This unique NovaFlex 'HDC' operator friendly feature makes connecting in awkward environments much easier. Assists with hose handling and alignment.

Flow optimized: NovaFlex 'HDC' delivers higher flow rates and lower pressure drop significantly reducing loading and turnaround times, reducing energy consumption and delivery costs.

Chemical

Advanced sealing technology: Extended seal life; significant up front and maintenance seal cost reduction. Coupler requires half the number of seals down to two O-rings.

Optimized valve arrangement: Fully interlocked for safe and dry release upon disconnection. Delivers higher flow rates with minimal loss on disconnection. The Novaflex HDC[™] is designed to handle aggressive acids including sulfuric acid, ethylene oxide and propylene oxide.

Locking and selectivity options: NovaFlex 'HDC' offers unique customization for chemical transfer operations.

Enhanced service feature: Enables easy access to all key replacement components for rapid field service and seal replacement without removing coupler from the hose or loading arm.

HDC-CPL 1" Stainless Steel 316L

Dry-Release Coupler

PART ID: 8CPLSV01

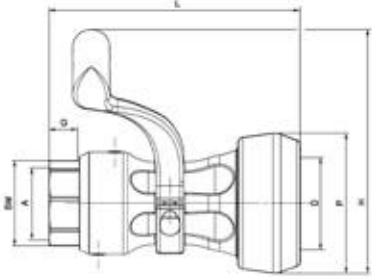

Material: Stainless Steel 316L

NPS Size	D Socket	A Connection	G Thread Length	L Length	P (without handle) Protection Ring	H (with Handle)	Weight kg/lbs	Pressure
1"	56 mm	BSP ISO 228-G 1	11 mm/0.43"	135.5 mm/5.33"	81 mm	141 mm	1.78 Kg/3.92lbs	25bar/362psi
1"	56 mm	NPT ANSI B2.1	22 mm/0.87"	135.5 mm/5.33"	81 mm	141 mm	1.75 Kg/3.85lbs	25bar/362psi

HDC-ADP 1" Stainless Steel 316L

Dry-Release Adapter

PART ID: 8ADPSV01

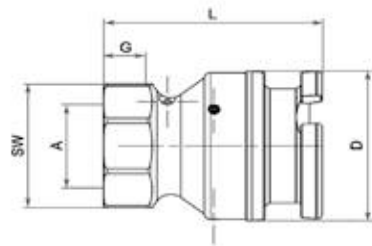

Material: Stainless Steel 316L

NPS Size	D Socket	A Connection	G Thread Length	L Length	Weight kg/lbs	Pressure
1"	56 mm	BSP ISO 228-G 1	11 mm/0.43"	68.5 mm/2.69"	0.52 Kg/1.15 lbs	25bar/362psi
1"	56 mm	NPT ANSI B2.1	22 mm/0.87"	77.5 mm/3.05"	0.59 Kg/1.30 lbs	25bar/362psi

Viton® is a registered trademark of DuPont Performance.

All data presented based on ambient temperature.

Novaflex HDC™ couplers and adapters equipped standard with Viton® seals. Other elastomers available upon request.

NovaFlex[®] Hi-Flow[™] Dry-Release[™] Couplings 'HDC'

HDC-CPL 1½" - 2" Stainless Steel 316L

Dry-Release Coupler
 PART ID: 8CPLSV01.5
 PART ID: 8CPLSV02

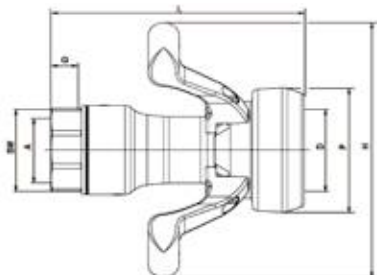

Material: Stainless Steel 316L

NPS Size	D Socket	A Connection	G Thread Length	L Length	P Protection Ring	H (with Handles)	Weight kg/lbs	Pressure
1½"	70 mm	NPT ANSI B2.1	18.4mm/0.72"	168 mm/6.61"	98 mm	200mm	2.4 Kg/5.31lbs	25bar/362psi
2"	70 mm	BSP ISO 228-G 2	20.0 mm/0.78"	164 mm/6.45"	98 mm	200mm	2.4 Kg/5.31lbs	25bar/362psi
2"	70 mm	NPT ANSI B2.1	21.5 mm/0.84"	168 mm/6.61"	98 mm	200mm	2.4 Kg/5.31lbs	25bar/362psi

HDC-ADP 1½" - 2" Stainless Steel 316L

Dry-Release Adapter
 PART ID: 8ADPSV01.5
 PART ID: 8ADPSV02

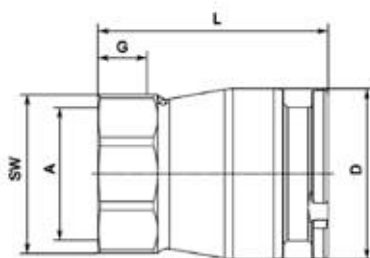

Material: Stainless Steel 316L

NPS Size	D Socket	A Connection	G Thread Length	L Length	Weight kg/lbs	Pressure
1½"	70 mm	NPT ANSI B2.1	18.4mm/0.72"	94.0 mm/3.7"	0.87 Kg/1.91lbs	25bar/362psi
2"	70 mm	BSP ISO 228-G 2	20.0 mm/0.78"	92.5 mm/3.64"	0.86 Kg/1.89lbs	25bar/362psi
2"	70 mm	NPT ANSI B2.1	21.5 mm/0.84"	94.0 mm/3.7"	0.87 Kg/1.91lbs	25bar/362psi

HDC-CPL 1½" - 2" Aluminum

Dry-Release Coupler
PART ID: 8CPLAV01.5
PART ID: 8CPLAV02

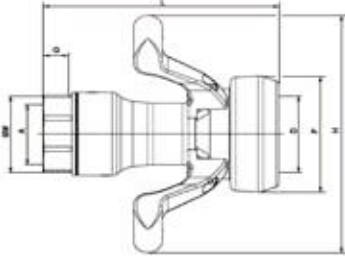

Material: Aluminum

NPS Size	D Socket	A Connection	G Thread Length	L Length	P Protection Ring	H (with Handles)	Weight kg/lbs	Pressure*
1½"	70 mm	NPT ANSI B2.1	18.4mm/0.72"	168 mm/6.61"	98 mm	200mm	1.2 Kg/2.64lbs	16-25bar/232-362psi
2"	70 mm	BSP ISO 228-G 2	20 mm/0.78"	164 mm/6.45"	98 mm	200mm	1.2 Kg/2.64lbs	16-25bar/232-362psi
2"	70 mm	NPT ANSI B2.1	21.5 mm/0.84"	168 mm/6.61"	98 mm	200mm	1.2 Kg/2.64lbs	16-25bar/232-362psi

HDC-ADP 1½" - 2" Aluminum

Dry-Release Adapter
PART ID: 8ADPAV01.5
PART ID: 8ADPAV02

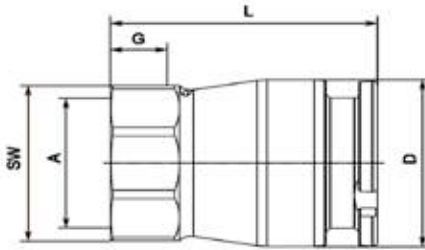

Material: Aluminum

NPS Size	D Socket	A Connection	G Thread Length	L Length	Weight kg/lbs	Pressure*
1½"	70 mm	NPT ANSI B2.1	18.4mm/0.72"	94 mm/3.7"	0.46 Kg/1.01lbs	16-25bar/232-362psi
2"	70 mm	BSP ISO 228-G 2	20.0 mm/0.78"	92.5 mm/3.64"	0.45 Kg/0.99lbs	16-25bar/232-362psi
2"	70 mm	NPT ANSI B2.1	21.5 mm/0.84"	94 mm/3.7"	0.46 Kg/1.01lbs	16-25bar/232-362psi

*High pressure model 25bar/362psi WP available

NovaFlex[®] Hi-Flow[™] Dry-Release[™] Couplings 'HDC'

HDC-CPL 3" Stainless Steel 316L

Dry-Release Coupler

PART ID: 8CPLSV03

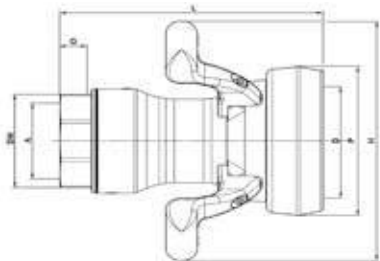

Material: Stainless Steel 316L

NPS Size	D Socket	A Connection	G Thread Length	L Length	P Protection Ring	H (with Handles)	Weight kg/lbs	Pressure
3"	119 mm	BSP ISO 228-G 3	24 mm/0.94"	232.5 mm/9.15"	160 mm	258mm	8.7 Kg/19.18 lbs	25bar/362psi
3"	119 mm	NPT ANSI B2.1	34 mm/1.33"	242.0 mm/9.53"	160 mm	258mm	9.0 Kg/19.84lbs	25bar/362psi

HDC-ADP 3" Stainless Steel 316L

Dry-Release Adapter

PART ID: 8ADPSV03

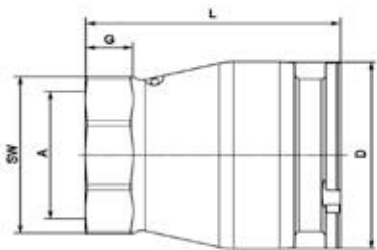

Material: Stainless Steel 316L

NPS Size	D Socket	A Connection	G Thread Length	L Length	Weight kg/lbs	Pressure
3"	119 mm	BSP ISO 228-G 3	24 mm/0.94"	134 mm/5.27"	3.4 Kg/7.49lbs	25bar/362psi
3"	119 mm	NPT ANSI B2.1	34 mm/1.33"	144 mm/5.66"	3.7 Kg/8.15lbs	25bar/362psi

HDC-CPL 3" Aluminum

Dry-Release Coupler

PART ID: 8CPLAV03

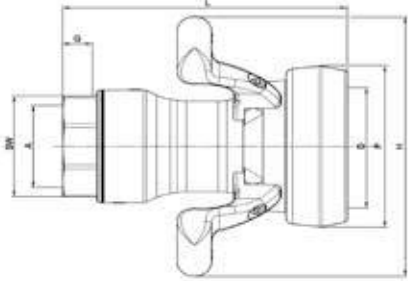

Material: Aluminum

NPS Size	D Socket	A Connection	G Thread Length	L Length	P Protection Ring	H (with Handles)	Weight kg/lbs	Pressure*
3"	119 mm	BSP ISO 228-G 3	24 mm/0.94"	232.5 mm/9.15"	160 mm	258mm	4.1 Kg/9.03lbs	16-25bar/232-362psi
3"	119 mm	NPT ANSI B2.1	34 mm/1.33"	242.0 mm/9.52"	160 mm	258mm	4.2 Kg/9.23lbs	16-25bar/232-362psi

HDC-ADP 3" Aluminum

Dry-Release Adapter

PART ID: 8ADPAV03

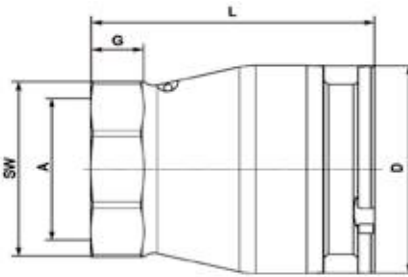

Material: Aluminum

NPS Size	D Socket	A Connection	G Thread Length	L Length	Weight kg/lbs	Pressure*
3"	119 mm	BSP ISO 228-G 3	24 mm/0.94"	134 mm/5.27"	1.8 Kg/3.96lbs	16-25bar/232-362psi
3"	119 mm	NPT ANSI B2.1	34 mm/1.33"	144 mm/5.66"	1.9 Kg/4.18lbs	16-25bar/232-362psi

*High pressure model 25bar/362psi WP available

NovaFlex[®] Hi-Flow[™] Dry-Release[™] Couplings 'HDC'

HDC-CPL 4" Stainless Steel 316L

Dry-Release Coupler

PART ID: 8CPLSV04

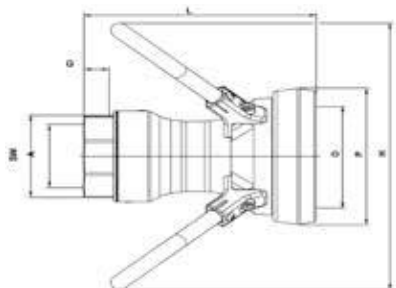

Material: Stainless Steel 316L

NPS Size	D Socket	A Connection	G Thread Length	L Length	P Protection Ring	H (with Handles)	Weight kg/lbs	Pressure
4"	164 mm	BSP ISO 228-G 4	24 mm/0.94"	295 mm/11.61"	210 mm	410mm	18.3 Kg/40.34 lbs	25bar/362psi
4"	164 mm	NPT ANSI B2.1	35 mm/1.38"	295 mm/11.61"	210 mm	410mm	18.1 Kg/39.90 lbs	25bar/362psi

HDC-ADP 4" Stainless Steel 316L

Dry-Release Adapter

PART ID: 8ADPSV04

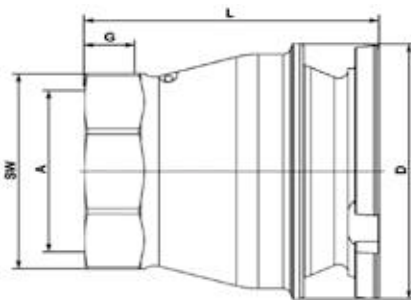

Material: Stainless Steel 316L

NPS Size	D Socket	A Connection	G Thread Length	L Length	Weight kg/lbs	Pressure
4"	164 mm	BSP ISO 228-G 4	24 mm/0.94"	156 mm/6.14"	6.9 Kg/15.21lbs	25bar/362psi
4"	164 mm	NPT ANSI B2.1	35 mm/1.38"	166 mm/6.53"	7.2 Kg/15.87lbs	25bar/362psi

HDC-CPL 4" Aluminum

Dry-Release Coupler

PART ID: 8CPLAV04

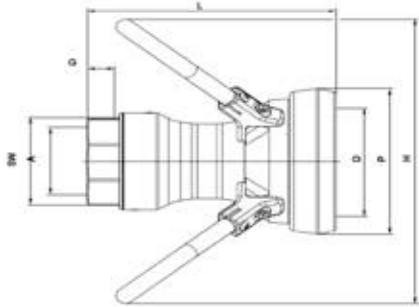

Material: Aluminum

NPS Size	D Socket	A Connection	G Thread Length	L Length	P Protection Ring	H (with Handles)	Weight kg/lbs	Pressure*
4"	164 mm	BSP ISO 228-G 4	24 mm/0.94"	295 mm/11.61"	210 mm	410mm	8.1 Kg/17.85lbs	16-25bar/232-362psi
4"	164 mm	NPT ANSI B2.1	35 mm/1.38"	295 mm/11.61"	210 mm	410mm	8.0 Kg/17.63lbs	16-25bar/232-362psi

HDC-ADP 4" Aluminum

Dry-Release Adapter

PART ID: 8ADPAV04

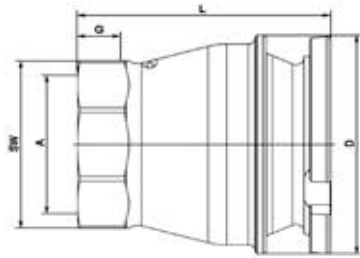

Material: Aluminum

NPS Size	D Socket	A Connection	G Thread Length	L Length	Weight kg/lbs	Pressure*
4"	164 mm	BSP ISO 228-G 4	24 mm/0.94"	156 mm/6.14"	3.4 Kg/7.49lbs	16-25bar/232-362psi
4"	164 mm	NPT ANSI B2.1	35 mm/1.38"	166 mm/6.53"	3.6 Kg/7.93lbs	16-25bar/232-362psi

*High pressure model 25bar/362psi WP available

NovaFlex[®] Hi-Flow[™] Dry-Release[™] Couplings 'HDC'

HDC-ADF 2" Stainless Steel 316L

Dry-Release Flanged Adapter

PART ID: 8ADFSV02

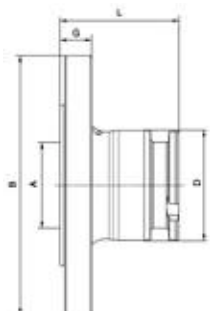

Material: Stainless Steel 316L

NPS Size	D Socket	A Connection	B Flange Diameter	G Flange Width	L Length	Weight kg/lbs	Pressure
2"	70 mm	ANSI B 16.5 2" Class 150	152.4 mm/6"	19.1 mm/0.75"	75 mm/2.95"	2.8 Kg/6.17lbs	16bar/232psi

HDC-ADF 2" Aluminum

Dry-Release Flanged Adapter

PART ID: 8ADFAV02

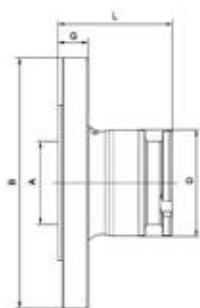

Material: Aluminum

NPS Size	D Socket	A Connection	B Flange Diameter	G Flange Width	L Length	Weight kg/lbs	Pressure
2"	70 mm	ANSI B 16.5 2" Class 150	152.4 mm/6"	19.1 mm/0.75"	75 mm/2.95"	1.1 Kg/2.42lbs	16bar/232psi

Other flange configurations available.

Novaflex HDC[™] couplers and adapters equipped standard with Viton[®] seals. Other elastomers available upon request.

HDC-ADF 3" Stainless Steel 316L

Dry-Release Flanged Adapter

PART ID: 8ADFSV03

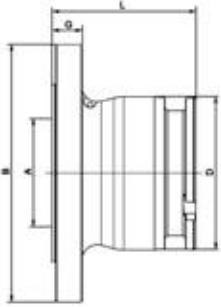

Material: Stainless Steel 316L

NPS Size	D Socket	A Connection	B Flange Diameter	G Flange Width	L Length	Weight kg/lbs	Pressure
3"	119 mm	ANSI B 16.5 2" Class 150	190.5 mm/7.5"	23.9 mm/0.94"	112 mm/4.4"	6.7 Kg/14.77lbs	16bar/232psi

HDC-ADF 3" Aluminum

Dry-Release Flanged Adapter

PART ID: 8ADFAV03

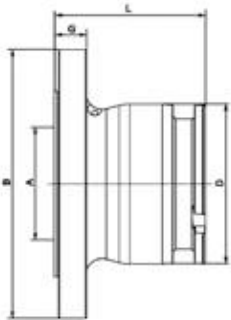

Material: Aluminum

NPS Size	D Socket	A Connection	B Flange Diameter	G Flange Width	L Length	Weight kg/lbs	Pressure
3"	119 mm	ANSI B 16.5 2" Class 150	190.5 mm/7.5"	23.9 mm/0.94"	112 mm/4.4"	2.9 Kg	16bar/232psi

NovaFlex[®] Hi-Flow[™] Dry-Release[™] Couplings 'HDC'

HDC-ADF 4" Stainless Steel 316L

Dry-Release Flanged Adapter

PART ID: 8ADFSV04

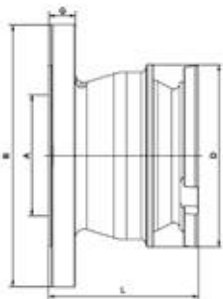

Material: Stainless Steel 316L

NPS Size	D Socket	A Connection	B Flange Diameter	G Flange Width	L Length	Weight kg/lbs	Pressure
4"	164 mm	ANSI B 16.5 2" Class 150	228.6 mm/9"	23.9 mm/0.94"	134 mm/5.27"	11.2 Kg/24.69lbs	16bar/232psi

HDC-ADF 4" Aluminum

Dry-Release Flanged Adapter

PART ID: 8ADFAV04

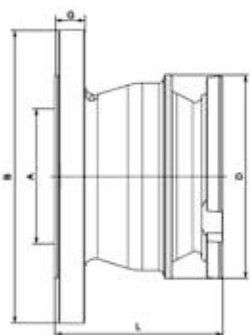

Material: Aluminum

NPS Size	D Socket	A Connection	B Flange Diameter	G Flange Width	L Length	Weight kg/lbs	Pressure
4"	164 mm	ANSI B 16.5 2" Class 150	254 mm/10"	23.9 mm/0.94"	134 mm/5.27"	4.9 Kg/10.80lbs	16bar/232psi

Performance Advancement

- **High Flow Co-Efficient**
- **Lower Pressure Drop**

NovaFlex 'HDC' by RS offers the lowest pressure drop and highest flow rates in the industry.

Developed from the ground up using the best expertise in the industry, this state of the art range brings numerous advancements resulting in 'Best in Class' flow performance, ease of use and maintenance.

In addition to minimal maintenance downtime, seal replacement costs have been reduced by up to 50%.

These important advancements translate into improved transfer times, energy savings, lower cost per hour operations, including with viscous fluids, safely and reliably.

Quality Assurance

No matter which part or component, each fitting is backed by the highest quality standards.

Each product is CE marked and conforms to the requirements of the European Pressure Equipment Directive; backed by ISO quality program and registered with the Technical Standards & Safety Authority TSSA (CRN registered in Canada).

From the start of manufacturing to the final shipment to our customers, each product is put through rigorous inspection and testing steps along the way.

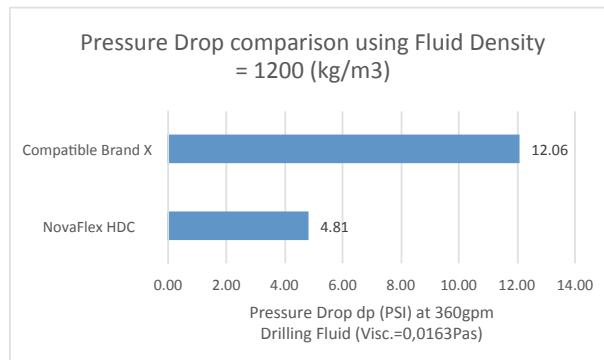
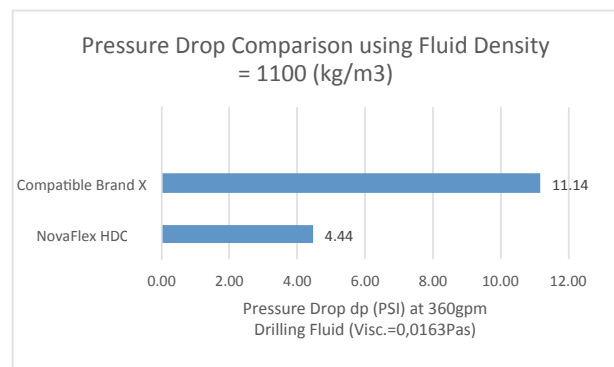
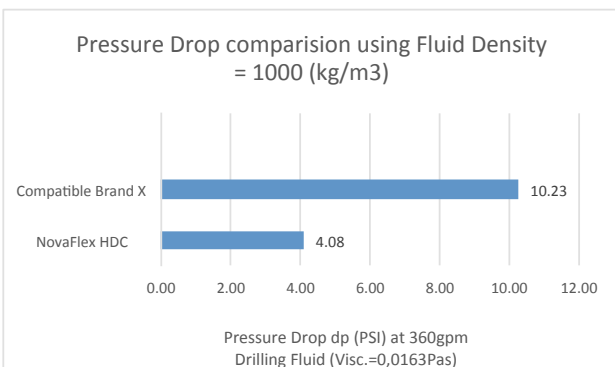
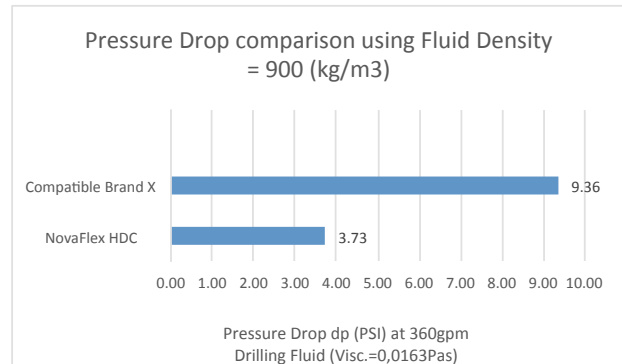
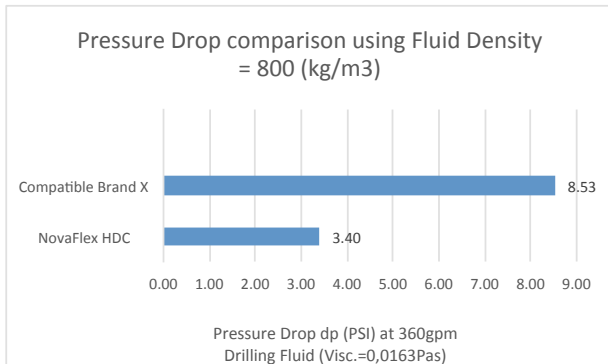

Data as tested by third party agency
e.g. 3" dia. for drill mud.

Flow Comparison - Novaflex HDC with Water

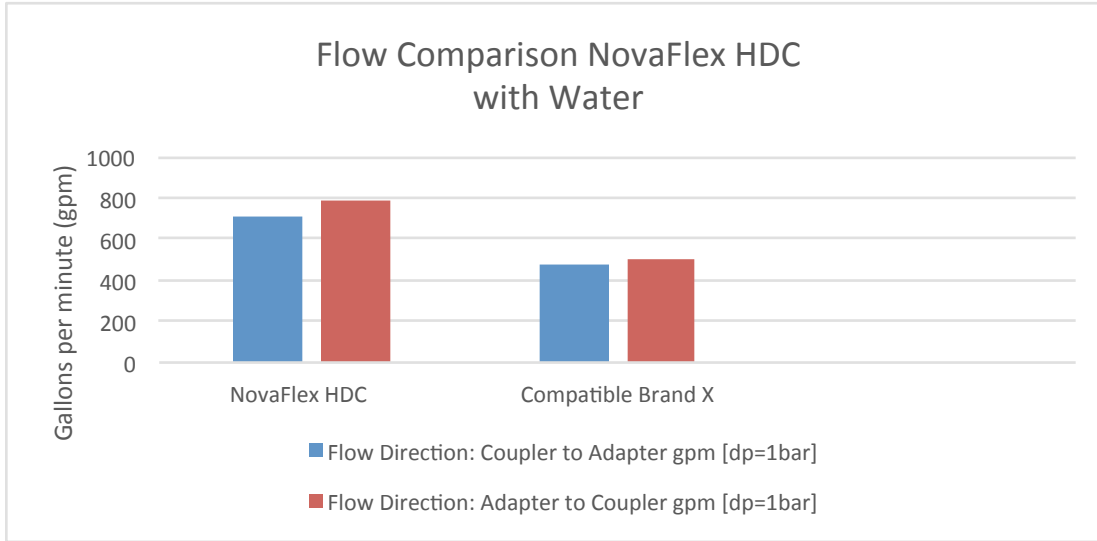

Flow Rates by Coupling Diameter

Size	Medium	PSI Δp	0.72	2.90	5.80	8.70	11.60	14.50	17.40	20.30	23.20	26.11	29.00	31.91
			0.05 [bar]	0.20	0.40	0.60	0.80	1.00	1.20	1.40	1.60	1.80	2.00	2.20
DN 25 / 1"	Water	$\Delta V/\Delta t$ [m ³ /h]	3.68	7.37	10.42	12.76	14.74	16.48	18.05	19.49	20.84	22.10	23.30	24.44
		$\Delta V/\Delta t$ [l/min]	61.40	122.80	173.67	212.70	245.60	274.59	300.80	324.90	347.33	368.40	388.33	407.28
		$\Delta V/\Delta t$ [gal/min](US)	16.22	32.44	45.88	56.19	64.88	72.54	79.46	85.83	91.76	97.32	102.59	107.59
DN 50 / 2"	Water	$\Delta V/\Delta t$ [m ³ /h]	10.41	20.81	29.43	36.05	41.62	46.53	50.98	55.06	58.86	62.43	65.81	69.02
		$\Delta V/\Delta t$ [l/min]	173.42	346.85	490.52	600.76	693.70	775.58	849.60	917.67	981.03	1040.54	1096.83	1150.37
		$\Delta V/\Delta t$ [gal/min](US)	45.81	91.63	129.58	158.70	183.26	204.89	224.44	242.42	259.16	274.88	289.75	303.89
DN 80 / 3"	Water	$\Delta V/\Delta t$ [m ³ /h]	40.04	80.08	113.25	138.70	160.16	179.06	196.15	211.87	226.50	240.24	253.23	265.59
		$\Delta V/\Delta t$ [l/min]	667.33	1334.65	1887.48	2311.68	2669.30	2984.37	3269.22	3531.16	3774.96	4003.96	4220.54	4426.54
		$\Delta V/\Delta t$ [gal/min](US)	176.29	352.58	498.62	610.68	705.16	788.39	863.64	932.83	997.24	1057.73	1114.95	1169.37
DN 100 / 4"	Water	$\Delta V/\Delta t$ [m ³ /h]	50.39	100.77	142.51	174.54	201.54	225.33	246.84	266.62	285.03	302.32	318.67	334.22
		$\Delta V/\Delta t$ [l/min]	839.77	1679.54	2375.22	2909.04	3359.07	3755.56	4114.01	4443.64	4750.45	5038.61	5311.16	5570.40
		$\Delta V/\Delta t$ [gal/min](US)	221.84	443.69	627.47	768.49	887.37	992.11	1086.81	1173.89	1254.94	1331.06	1403.06	1471.54

Flow Rates by Coupling Diameter with Water

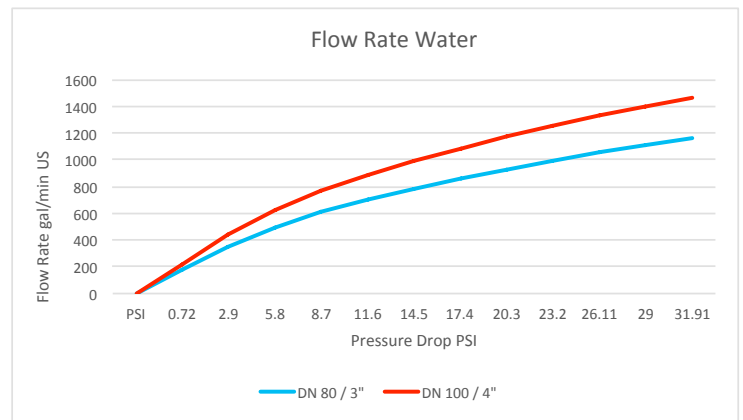
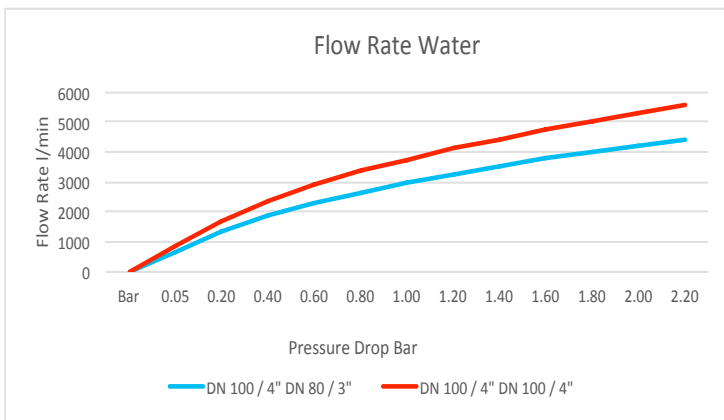
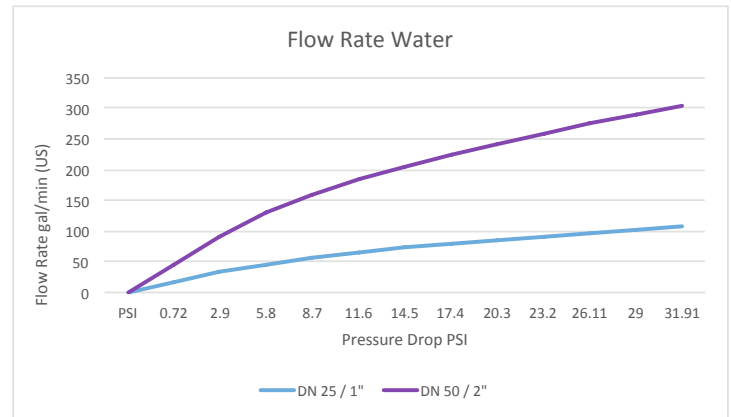
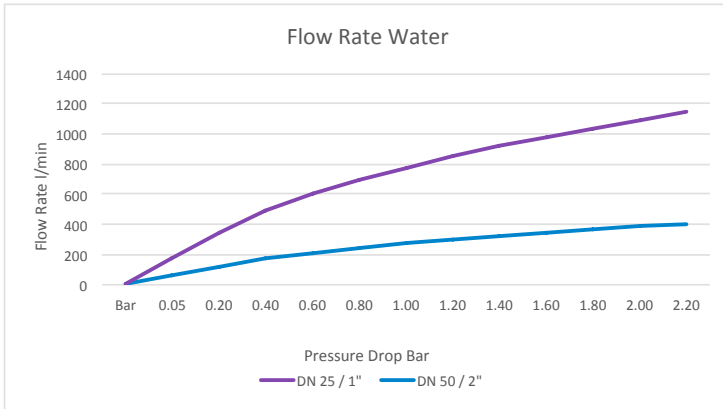

All products by Novaflex® are warranted to be free from all defects in material and workmanship.

It is impossible to test Novaflex® products under all conditions to which they might be subjected in the field. It is therefore the buyer and/or end user's responsibility to test all Novaflex® products under conditions that duplicate the service conditions prior to installation.

Prior to any application of the information within, please read carefully the following information:

This catalogue is a guide for use in selecting the product for the correct application. It contains warnings, reference directions and directions for safe use. All guidelines should be clearly understood before specifying or using any Novaflex® product. Failure to follow recommended application information and recommended procedures may result in premature failure, resulting in bodily injury or property damage. Contact Novaflex® or your local Novaflex® distributor for assistance.

For all Novaflex® products, always consult the most recent Proper Care and Maintenance Guides and Chemical Resistance Charts, available on our web site at www.novaflex.com

Due to continuous improvements, technical data is subject to change without notice.

NovaFlex® Hi-Flow™ Dry-Release™ Couplings 'HDC'

Dust Caps & Plugs



Maintenance Tool



For simple, fast maintenance of key internal components

Novaflex® SBC Safety Breakaway Couplings

Eliminate Risk of Unwanted Spill in Accidental Pull-Away/Drive-Away

Safety Breakaway Couplings, a passive valve for use in virtually all fixed and flexible fluid transfer systems, offer optimum safety without work loss. The valves in both halves close automatically before the coupling disconnects completely eliminating any possible product loss in the event of an accidental drive-away or pull-away. The unique valve mechanism guarantees a high flow rate and a low pressure drop and can release at any angle of pull.

- High flow rate/low pressure drop
- Valves in both halves close automatically before the main fluid seal releases to the atmosphere
- Ultra compact design encapsulated shear bolts for protection from external damage
- Will release at any angle of pull easily re-set on-site with one person
- Operates independently of shut off safety systems
- Does not require an external power source
- Used on loading arms and hose

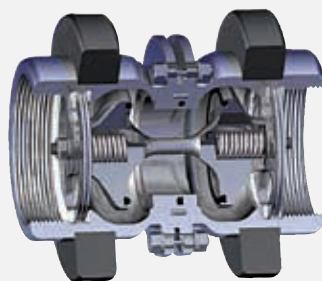

Before emergency separation

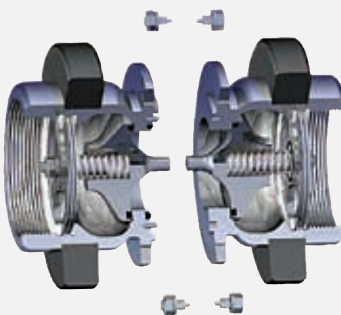

After emergency separation



ABVL - HighFlow SBC



ABML - Marine In-line hose string SBC



The NovaFlex Group is a market leader through excellence in product innovation and design. The NovaFlex Group is a privately held company committed to continuous advancement in hose and connector solutions.

NovaFlex® has one of the broadest product ranges available in the hose and ducting marketplace, as well as the HVAC, Industrial Venting, Dry-Release™ Coupling and Commercial Exhaust Venting Systems.

Products are sold in industries across North America and around the world.



U.S.A.

WEST BERLIN NEW JERSEY

Tel 856.768.2275
Fax 856.768.2385
Toll Free 800.225.0215

INDIANAPOLIS INDIANA

Tel 317.334.1444
Fax 317.334.1535
Toll Free 800.526.6288

HAW RIVER NORTH CAROLINA

Tel 336.578.2161
Fax 336.578.5554
Toll Free 800.334.4270

CANADA

AJAX ONTARIO

Tel 905.686.5200
Fax 905.686.8349

MONTREAL QUEBEC

Tel 514.697.3701
Fax 514.697.3767

CALGARY ALBERTA

Tel 403.277.3115
Fax 403.276.1309

OTTAWA ONTARIO

Tel 613.744.7360
Fax 613.744.7366

DELTA BRITISH COLUMBIA

Tel 604.940.6401
Fax 604.940.6402

RICHMOND HILL ONTARIO

Tel 905.731.9411
Fax 905.731.7086

U.K.

BROMBOROUGH WIRRAL U.K.

Tel 44.(0)151.334.0873
Fax 44.(0)151.334.7145
Email: sales@novaflex.co.uk